

BASIC ELECTRONICS for the Petroleum Industry

FOURTH EDITION

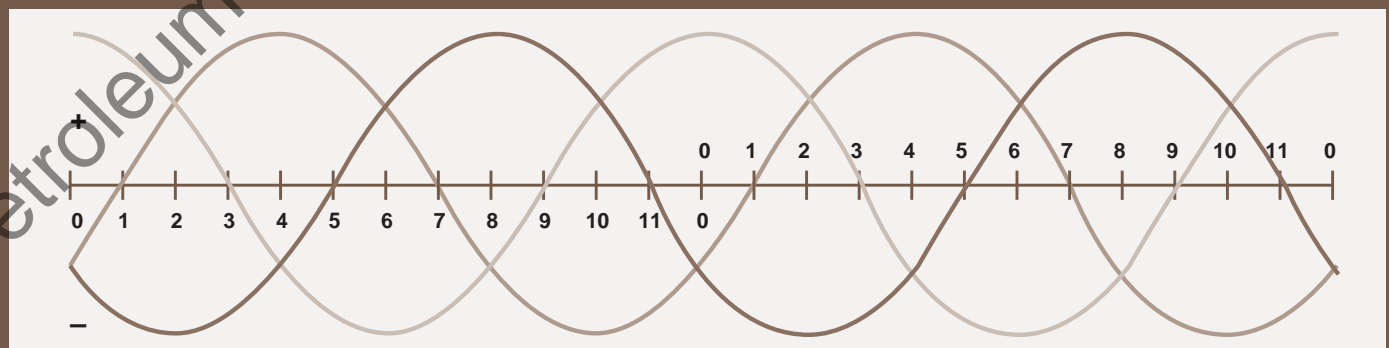
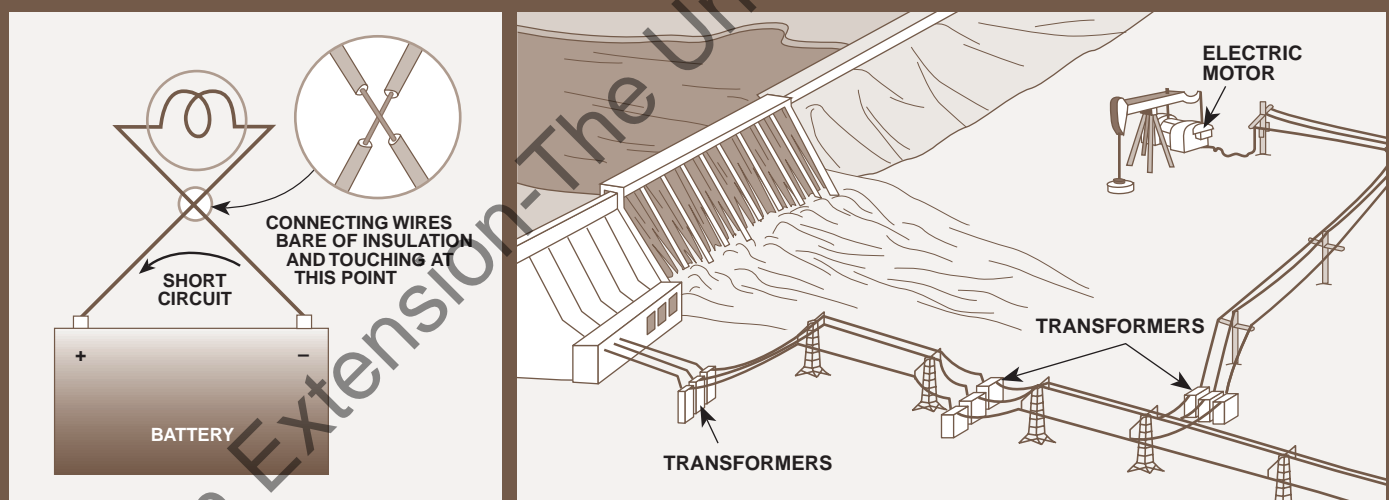
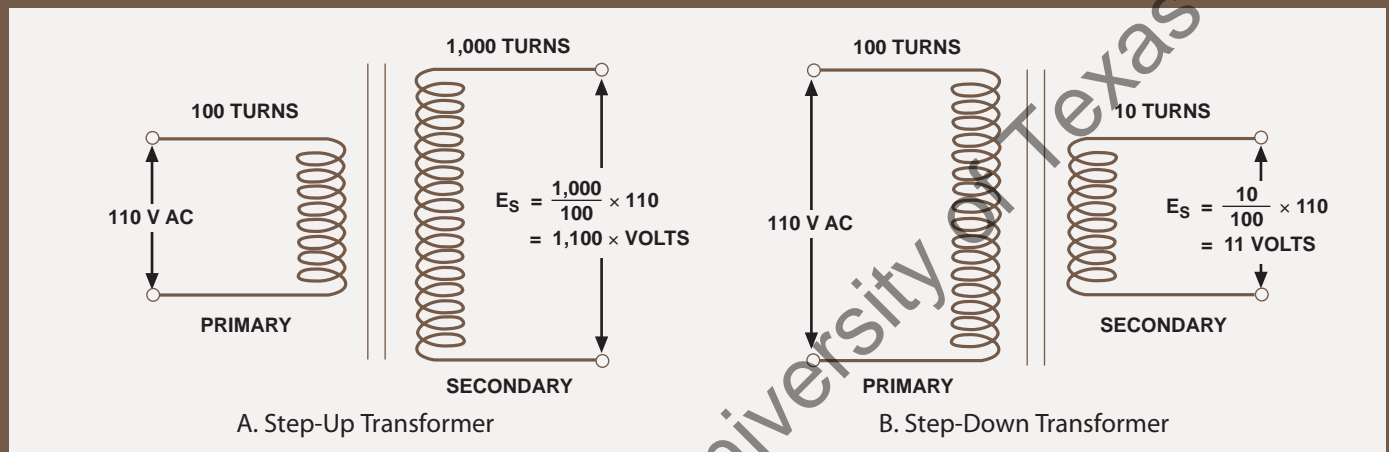

Contents

Figures	vii	
Tables	xi	
Preface	xiii	
Acknowledgments	xv	
About the Author	xvii	
Chapter 1. Basic Mathematics		1
Addition	1	
Subtraction	2	
Multiplication	2	
Division	3	
Exponents	3	
Equations	5	
Subscripts	7	
Binary Numbers	8	
Octal Numbers	8	
Hexadecimal Numbers	9	
Binary Coded Decimal Code	9	
American Standard Code for Information Interchange	9	
Gray Code	10	
Review Questions	10	
Chapter 2. The Nature of Electricity		11
Atoms	11	
Voltage	12	
Current	13	
Resistance	13	
Introduction to Ohm's Law	14	
Introduction to Power Law	14	
Review Questions	14	
Chapter 3. Galvanic Cells and Batteries		15
Galvanic Cells	15	
Batteries	15	
Review Questions	18	
Chapter 4. Ohm's and Power Laws		19
Circuits	19	
Ohm's Law	19	
Power Law	19	
Ohm's Law Examples	20	
Simple Circuits	21	
Series Circuits	22	

Parallel Circuits	23	
Malfunctioning Circuits		24
Switches in Circuits	25	
Review Questions	26	
Chapter 5. Conductors and Insulators		27
Characteristics of Materials	27	
Current-Carrying Capacity of Conductors		28
Relationship Equation	30	
Review Questions	32	
Chapter 6. Properties and Characteristics of Magnetism		33
Magnets and Magnetism		33
History	33	
Earth as a Giant Magnet	33	
Magnetic Properties	34	
Nature of Magnetism	34	
Types of Magnets	36	
Current and Magnetic Fields		38
Coils	40	
Magnetic Circuits	41	
Review Questions	45	
Chapter 7. Induction Principles and AC Generators		47
Alternating Current	47	
Direct Current	47	
Electric and Magnetic Fields	47	
Electromagnetic Induction	48	
Alternating Current Properties		53
Review Questions	55	
Chapter 8. Electrical Components, Impedance, and Power		57
Resistors	57	
Potentiometers	63	
Inductors and Inductance		66
Capacitors and Capacitance		68
Impedance	77	
Power	78	
Review Questions	80	
Chapter 9. Electromagnetic Equipment		81
Transformers	81	
Filter Choke Coils	89	
Induction Motors	89	
Power Factor	96	
Solenoids	100	
Electromechanical Relays		101
Review Questions	101	
Chapter 10. Semiconductors and Applications		103
Basic Semiconductor Theory	103	
Semiconductor Diodes	106	
Bipolar Transistors	110	

Field-Effect Transistors	117	
MOSFETs	119	
Solid-State Designations	119	
Integrated Circuits	119	
Review Questions	126	
Chapter 11. Digital Logic	129	
Binary Numbers	129	
Digital Logic	132	
Solid-State Logic Gates	137	
Sequential Logic and Memory Devices	140	
Flip-Flop Circuits	141	
Logic Counter Circuits	147	
Encoders and Decoders	150	
Storage of Binary Information	152	
Review Questions	152	
Chapter 12. Electrical Test Instruments	153	
d'Arsonval Movements	153	
Multimeters	159	
Oscilloscopes	161	
Additional Test and Measuring Instruments	170	
Test Instrument Overview	171	
Review Questions	171	
Chapter 13. Troubleshooting Techniques and Safety	173	
Recordkeeping	173	
Familiarity with Equipment	174	
Operation and Maintenance Manuals	174	
Test Instruments	175	
Troubleshooting Steps	177	
Circuit Testing	180	
Troubleshooting Intermittent Malfunctions	181	
Field Troubleshooting	181	
Remote Terminal Units	181	
Field Troubleshooting Instruments	182	
Shop Troubleshooting	182	
Electrical Safety	183	
Safety Summary	189	
Review Questions	189	
Glossary	191	

1 Basic Mathematics

To understand electrical relationships in circuits and components, you must also understand mathematics. Mathematics—math, for short—helps you visualize how electricity and electrical *circuits* work. The math that follows is basic and is offered mainly as a refresher to those who may be out of practice in working with numbers.

ADDITION

Addition unites, or puts together, two or more things that are often represented by a symbol called a *number*. (Numbers are also called *integers* and *digits*.) The number obtained by adding two or more numbers is the *sum*, or total. The character for addition is the plus sign (+).

The first step in addition is to arrange the numbers to be added in vertical columns, such as those in Table 1. In numbers with more than one digit, the column on the right is the ones column. This column contains a one-digit number: 1, 2, 3, 4, and so on up to 9. The next column to the left of the ones column is the tens column. It is the tens column because the

digits, or numbers, in this column are 10 or multiples of 10, as 20, 30, 40, and so on up to 90. The next column to the left is the hundreds column. The digits in this column are 100 or multiples of 100 up to 900.

This columnar arrangement continues to the left in thousands, ten thousands, millions, billions, and so on. For example, the number 8,649 can also be expressed as having nine ones, four tens, six hundreds, and eight thousands.

Regardless of the sizes of the numbers, to add them correctly, the last digit to the right in each number should be placed directly under the other in a vertical column. For example, to add 14, 7, 121, and 2,390, they should be arranged as—

```

14
 7
121
2,390
    
```

Notice that the numbers line up—are flush—with the right-hand ones column. Put another way, the numbers are flush right. Also notice that as long as the numbers are flush right, they may be written in any order. For example, the previous four numbers can be written as—

```

 7
2,390
14
121
    
```

or in any other order and the correct answer can be obtained. Remember, however, that the numbers must be flush with the right-hand column.

Always begin by adding the numbers in the right-hand, ones column first. If the sum can be expressed by one digit, from 0 to 9, write it under the column. If, on the other hand, the sum contains more than one digit, (10 or more), write the right-hand digit of the sum under the column added, and add (or *carry*) the remaining digits to the next column on the left. For example, if the sum of the column is 23, write 3 under the column, and add 2 to the sum

TABLE 1

**Numbers Arranged in Vertical Columns
of Hundreds, Tens, and Ones**

Hundreds	Tens	Ones
100	10	1
200	20	2
300	30	3
400	40	4
500	50	5
600	60	6
700	70	7
800	80	8
900	90	9

The Nature of Electricity

Matter is anything that has *mass* or weight and occupies space. Mass is the quantity of matter that a substance contains. It is related to weight, but, unlike weight, mass is independent of external conditions such as buoyancy of the atmosphere or acceleration caused by gravity. For example, an object on earth may weigh 24 grams, but the same object on the moon weighs only 4 grams. Because the earth's gravity is six times that of the moon, the object weighs six times more on the earth than it does on the moon. However, if an object on earth has a mass of 24 grams, it has a mass of 24 grams whether it is on the moon or anywhere else in our universe.

Matter is electrical in nature. The three forms of matter are solids, liquids, and gases. Matter is made up of elements and combinations of elements. An *element* is an individual substance not made up of other elements or substances. For example, the element copper is not made up of other substances. An element consists of only one kind of atom. Atoms make up the smallest substance within an element and are the fundamental building blocks of our universe.

About 100 elements occur naturally, but chemists and physicists have created more in nuclear laboratories, so that 115 have been identified at this time. Future experiments may yield even more. In any case, elements combine chemically to form materials found in everyday life. For example, the elements sodium and chlorine combine to form sodium chloride, which is ordinary table salt.

As stated earlier, an *atom* is the smallest unit of an element. When the atoms of an element combine with themselves or with other elements, they form a *molecule*. For example, oxygen, which has the chemical symbol of O, naturally occurs as a molecule, the symbol of which is O₂. An oxygen molecule is abbreviated as O₂ to indicate that it is composed of two atoms of oxygen. Similarly, a molecule of sodium chloride, or table salt, is abbreviated as NaCl—sodium is Na and the chloride molecule is Cl. NaCl

means that a sodium atom and a chloride molecule combine to form a molecule of table salt.

Sometimes elements merely mix together and do not combine chemically. Such a combination is a *mixture*. Examples of mixtures are natural gas, steel, brass, and air. Air, for example, is a mixture of several gases, such as nitrogen, oxygen, and carbon dioxide. These gases do not react chemically; so, they are a mixture.

ATOMS

As mentioned earlier, the atom is the smallest division of an element. An atom consists of a heavier part called the *nucleus* and very small particles revolving around it called *electrons*. The nucleus is the central region of an atom, composed of protons and neutrons and containing almost all of the mass of the atom. The mass of an electron is very small; indeed, an electron's mass is only 9.1×10^{-28} grams. 9.1×10^{-28} means 9.1 with the decimal point shifted 28 places to the left. Thus, the mass of an electron is very small indeed. Besides being very light in mass, an electron exhibits a quality that is called a *negative charge*. Usually, we simply say that electrons are negatively charged.

The nucleus of the atom contains particles called *protons* and *neutrons*. These particles are about 1,845 times heavier than the electron. The proton exhibits an opposite and equal relation to the electron and has a positive electrical charge. Neutrons have no electrical charge—that is, they are *neutral*. Other particles and forces exist in the nucleus, and nuclear scientists spend a great deal of time studying them.

When two or more atoms unite chemically and the properties of the separate elements are changed, a *compound* is produced. The smallest unit of a compound is the molecule, which, as mentioned previously, contains two or more atoms.

Atoms have different amounts of electrons, protons, and neutrons. Indeed, it is the different number of electrons, protons, and neutrons that account for

Galvanic Cells and Batteries

Electrical and electronic circuits require a source of voltage to function. Current does not flow unless a source of electrical pressure acts on the circuit components. Direct current (DC) sources include electrochemical devices such as *galvanic cells* and *batteries*. Although solid-state devices are another source of DC, they are discussed in another section. Many devices deliver voltage, including *electrochemical cells*, or batteries, *photovoltaic cells*, and *thermoelectric devices*. Each of these devices produces DC voltage that can deliver current to components and equipment.

GALVANIC CELLS

An electrochemical, or galvanic, cell is built by using the proper chemicals and two dissimilar materials immersed in, or surrounded by, the chemicals. A conductor or an electronic device is attached to each end of the dissimilar materials. The place where the connections are made is called a terminal. One terminal has a negative charge and the other has a positive charge. The negative terminal has an excess of electrons, and the positive terminal has a lack, or deficiency, of electrons. This situation sets up an energy difference between the two terminals, which is called potential or potential difference.

If an external path or a component is connected to the terminals, the potential causes the free electrons and corresponding holes to move through the external path or component. The holes flow from the positive terminal to the negative terminal of the cell. This movement of holes in one direction is referred to as *current*.

A device consisting of a single-positive and a single-negative terminal along with activating chemicals is referred to as a *cell*. A cell is the smallest unit of this type of device. A typical cell contains sulfuric acid as its *electrolyte* and two dissimilar terminals made of lead and a lead compound. This cell is a *lead-acid cell*. It produces a voltage of about two volts. (An electrolyte is a chemical that, when dissolved

in water, dissociates into positive and negative *ions*, thus increasing its electrical conductivity. An ion is simply a positively- or negatively-charged atom.)

BATTERIES

A battery is made up of several galvanic cells connected in *series* to produce a voltage higher than that of one cell. (Connecting an electrical device or circuit in series means that current can travel only in a single path. Also, the current is the same throughout the device or circuit.) The kind of electrical charge at a cell or battery's terminal determines the terminal's *polarity*. A terminal's polarity is either positive or negative, depending on whether its electrical charge is positive or negative. That is, if the terminal's electrical charge is positive, the terminal is said to have positive polarity. Conversely, if the terminal's charge is negative, it has negative polarity.

A common lead-acid battery is an automobile battery. Typically, such a battery consists of six galvanic cells connected in series to produce a voltage at its terminals of 12 volts DC. One terminal is positive (+) while the other is negative (-).

Strictly speaking, a battery is formed only when two or more cells are connected. However, it is customary to call a single cell a battery. Although not strictly correct, this manual follows conventional usage and also refers to a single cell as a battery.

Construction of Batteries

Many years ago, humans discovered that if a person placed two different metals in a liquid so that they did not touch each other, and if the liquid reacted chemically with the metals, a potential difference, or voltage, was set up between the metals. This arrangement is a cell. For example, a lead-acid cell is made with a lead plate and another plate with lead peroxide pressed into its grids. The negative plate is the lead plate, and the positive plate is the lead

1 Ohm's and Power Laws

CIRCUITS

A *circuit* is a complete path in which current will flow. The path is from one battery terminal, or another source of voltage, back to the other battery terminal. The three elementary circuits are *simple*, *series*, and *parallel*. A simple circuit consists of a single path from one terminal of a source of electricity, through one electrical device, and back to the terminal of the electricity source. For example, one simple circuit consists of a battery, a light bulb, and a conductor such as copper wire. Current flows from the negative terminal of a battery, through the copper wire and light bulb, and back to the battery's positive terminal. A series circuit consists of a single path from the battery or source of voltage through two or more electrical devices back to the other terminal of the battery. A parallel circuit consists of two or more complete and separate paths for current flow.

Incidentally, circuits often contain *resistors*. Resistors are electrical devices that oppose the flow of electricity through a circuit. Besides the actual electrical component that is called a resistor, other devices in a circuit create resistance when they convert electrical energy into another form. For example, an incandescent lamp creates resistance as it converts electrical energy to light, and an electric heater creates resistance as it converts electric energy to heat.

OHM'S LAW

Ohm's law states that the strength or intensity of an electrical current (I) is directly proportional to the electromotive force (E) and inversely proportional to the resistance (R) of the circuit. Ohm's law relates voltage, which is the electrical pressure that causes the current flow; current, which is the rate at which electrons flow; and resistance, which is the opposition that a circuit offers to the flow of electrons.

Ohm's law can determine the amount of current that will flow in a circuit. In this case, use $I = E/R$ to find the current in amperes. To determine the amount

of resistance, in ohms, in a circuit to limit current to a given value, use $R = E/I$. Finally, to determine the voltage needed to create a flow of current through a given resistance, use $E = IR$. When two variables (voltage, current, or resistance) are known, Ohm's law provides an easy way to find the third by selecting the Ohm's law equation that has the unknown on the left side.

A drawing is available for finding the appropriate Ohm's equation to solve a problem. Called the Ohm's law wheel (fig. 7), it shows how to select the correct equation. For example, if values for E and R are known, then it shows that $I = E/R$. Similarly, if values for I and R are known, then the wheel shows that $E = IR$.

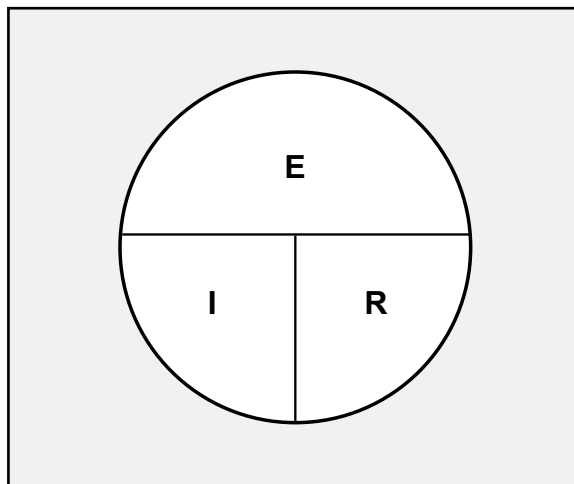

Figure 7 Ohm's law wheel

POWER LAW

As you recall, besides Ohm's law, the *power law* is available to determine the power a circuit is capable of producing. Like Ohm's law, the power law also consists of three variables; voltage, E or V , measured in volts; current, I , measured in amperes; and power, P , measured in watts. In equation form, the power law is $P = EI$, or $P = VI$. To determine the amount of

5 Conductors and Insulators

CHARACTERISTICS OF MATERIALS

Various materials exhibit various electrical properties. For example, materials such as aluminum, copper, and silver have low resistance. Consequently, they make good conductors of electricity. Thus, they are often braided or drawn to make wire, or *cable*, for connecting electrical components. Connecting wire should have low resistance so that little of the available voltage is lost while the equipment is operating. Therefore, resistance of wires and cables should be as low as economically possible. Economics is an important factor. For example, silver has less resistance—is a better conductor—than copper or aluminum; however, silver is much more expensive, so it is seldom used.

Another consideration is that one conductor should not make contact with another conductor at a different voltage, or potential. A short circuit can develop, which is a malfunction. To prevent short circuits, insulating materials cover conductors at various points in the circuit. Rubber or plastic thick enough to be effective is one material that can coat wires and cables to prevent short circuits and the damage they cause.

Also, some wire and cable not only have plastic insulation for protection, but also an outer metal *cladding*, or coating. This cladding may be solid aluminum sheathing or braided copper. In either case, the cladding protects the cable or wire from mechanical damage—that is, it protects the cable when it is struck or crushed by an outside force such as a dropped tool, people stepping on it, or similar forces.

Figure 19 shows several insulated wires. The 300-ohm *ribbon line* at the top is often used to connect an antenna to a television set. The 72-ohm double-wire transmission line is used in various gauges to conduct alternating current in households, industrial plants, offices, and so on. *Coaxial cable* has many uses. It is called coaxial because several wire conductors are bundled around each other to form a single, although thick, wire. *Hookup wire* is used to wire

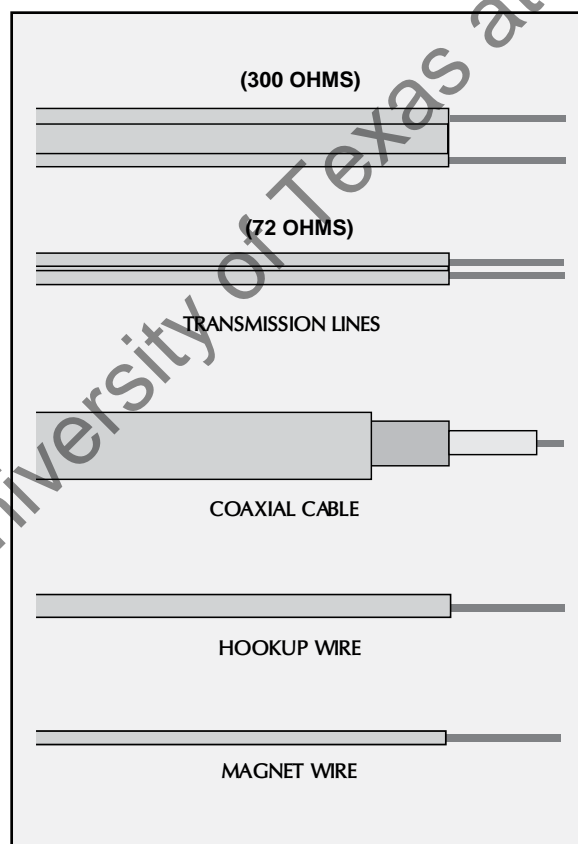

Figure 19 Examples of insulated wires

electrical components together in equipment such as amplifiers and other electronic devices. *Magnet wire* is a copper conductor that is insulated with thin enamel or enamel-like coating. Prior to making a connection with it, this coating must be scraped away from the wire. Magnet wire gets its name from its use as windings in electromagnets, transformers, motors, and generators. Its insulation must be thin so that it can be wound several times around a core: thick insulation would not allow it to be wound an adequate number of times. So, instead of a plastic coating, varying grades of enamel or varnish are baked onto magnet wires to provide good insulating properties.

Properties and Characteristics of Magnetism

A close relationship exists between electricity and magnetism. Therefore, it is important to learn about magnetism and its relation to electronics.

MAGNETS AND MAGNETISM

A *magnet* is a piece of iron or steel that attracts other bits of iron or steel. *Magnetism* is the force that occurs when a magnet attracts iron. Magnetism also occurs when electricity moves through a conductor. Put another way, magnets and certain electrical devices exhibit magnetism. Magnetism is responsible for the operation of generators, magnetos, motors, voltmeters, relays, and many other important devices.

Magnetism can transform electrical energy into mechanical energy and mechanical energy into electrical energy. For example, an electric motor transforms electrical energy into mechanical energy because electricity turns a shaft in the motor. Then, when the shaft is connected to another device, such as a pump, it performs mechanical energy, or work. On the other hand, a generator transforms mechanical energy into electrical energy. For example, when a device that provides power, such as a diesel engine, is hooked up to a generator to make it turn, the generator makes, or generates, electricity.

HISTORY

Over 2,000 years ago, humans discovered that a type of naturally-occurring iron ore possessed the peculiar property of being able to attract small pieces of iron. The Greeks named this iron ore, which was a form of iron oxide, *magnetite*. Later, ancient explorers found that an elongated piece of magnetite, if suspended by a string, would always point in the same direction. People then began to navigate using magnetite as a compass. Because it led early explorers in their travels, they called it *lodestone*, which means way stone, in the sense that the stone led the way. Today, lodestone is important mainly

because of its historical interest; nevertheless, it was the beginning of humankind's knowledge of magnetism. It was not until the 1800s, however, that scientists began to investigate and to discover the properties of magnetism.

EARTH AS A GIANT MAGNET

The earth is a huge magnet and is surrounded by a *magnetic field*. The earth has *magnetic poles* and *geographic poles* (fig. 20). Because the earth's magnetic axis does not quite coincide with the geographic axis, the magnetic and geographic poles are not at the same place on the surface of the earth. This fact is important to those who plot courses or find directions when traversing the earth. This difference in the location between the magnetic pole, or *magnetic north*, and the geographic pole, or *true north*, is the *angle of declination*, or *magnetic deviation*.

Magnetic deviation varies from place to place on the earth. Because declination varies, geographers

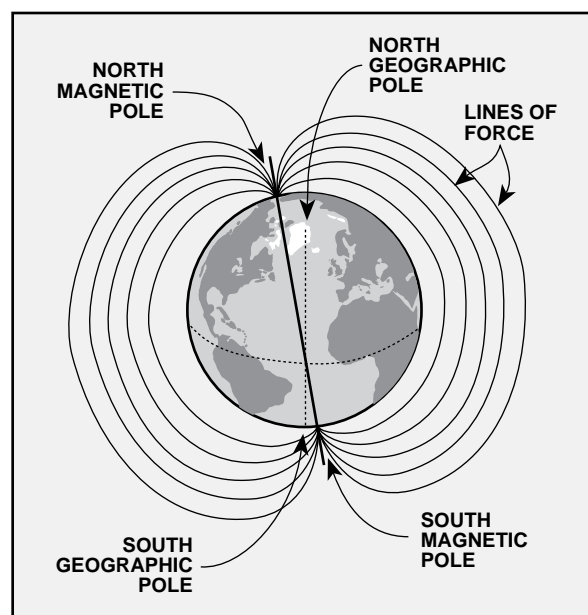

Figure 20 Earth's poles and magnetic lines of force

Induction Principles and AC Generators

ALTERNATING CURRENT

Alternating current (AC) is current that periodically reverses its direction of flow in a circuit and constantly changes its strength, or *amplitude*. One source of alternating current is an AC generator, which is an alternator. The current occasionally reverses its direction of flow in a circuit because the terminals of the alternator are constantly reversing their polarity. That is, a terminal of the AC generator is positive at one instant, negative the next instant, then positive, then negative, and so on. During the time that one terminal is positive, the other terminal is negative. When the terminals of the alternator reverse their polarity, the direction of current flow in the circuit also reverses, because conventional current always flows from positive to negative.

When current changes its direction of flow, the strength, or amplitude, of the current also changes. Current strength falls to zero at the instant the reversal in direction of flow occurs. This phenomenon is similar to a person's traveling due east and deciding to change direction. The person must come to a stop, at least momentarily, before he or she can travel due west. Similarly, the strength of alternating current changes from zero to a maximum in one direction, then falls to zero and rises to a maximum in the other direction, and returns to zero again. This action is repeated as long as current is flowing.

DIRECT CURRENT

Direct current (DC), on the other hand, flows in one direction; its strength, or amplitude, remains constant. When a circuit is connected to a battery, the current flows from the positive terminal of the battery through the circuit to the negative terminal of the battery in one direction. To reverse the current's direction through the circuit, the battery terminals must be reversed. Reversing the battery terminals is the only way to reverse the current's direction through the circuit. The positive terminal of a battery remains positively charged; it never becomes negative. Moreover, a bat-

tery's negative terminal never becomes positively charged. Likewise, the connecting wire that leads to the positive terminal of the battery is positive.

The two most important sources of DC current are batteries and DC generators. Each has a positive and a negative terminal, which are usually marked plus (+) for positive and minus (-) for negative.

ELECTRIC AND MAGNETIC FIELDS

Magnetic devices include such equipment as relays, motors, and transformers. Because they are magnetic devices, they are usually discussed in terms of their magnetic fields. On the other hand, conventional electrical devices, such as radio circuits and the like, are usually discussed in terms of their electric fields. Further, just as magnetic devices have magnetic fields and magnetic lines of force, conventional electrical devices have electric fields and electric lines of force. Electric lines of force exist whenever a difference in potential occurs, such as around the terminals of a battery, or around power lines.

Moreover, if an *atomic particle*, such as an electron or proton, is charged, electric lines of force are associated with it, too. If the particle is an electron, it is negatively charged. In this case, the lines go out of the particle (fig. 39A). If the particle is a proton, it is positively charged, and the lines go into the particle (fig. 39B).

Particles with unlike charges—that is, one has a positive charge and the other has a negative charge—are attracted to each other. This fact leads to the expression, “unlike charges attract.” Electric lines of force, just as magnetic lines of force, always tend to travel the shortest route possible, and the shortest distance for the lines is between two unlike charges (fig. 39C). Thus, they attract.

On the other hand, when particles with like charges are brought together, they tend to repel—that is, “like charges repel.” Like charges repel because the lines around the charges collide head on and therefore oppose each other (fig. 39D).

Electrical Components, Impedance, and Power

RESISTORS

Although several materials resist the flow of electric current, most circuits require a specific resistance to operate properly. For example, electronic amplifiers, control circuits, instrumentation loops, and similar devices require resistors of a fixed value. When electricity flowing in a circuit encounters a resistor, the resistor reduces the voltage to a specific and required amount. Resistors provide the correct operating voltage to a component or to another part of the circuit. In short, resistors create voltage drops where they are wired into the circuit.

Resistors are made from (1) a special wire, (2) a mixture composed of conductive and nonconductive materials termed a *composition*, or (3) a thin membrane, or skin, called *film*. Figure 46 shows a wire-wound resistor, a composition resistor, and the

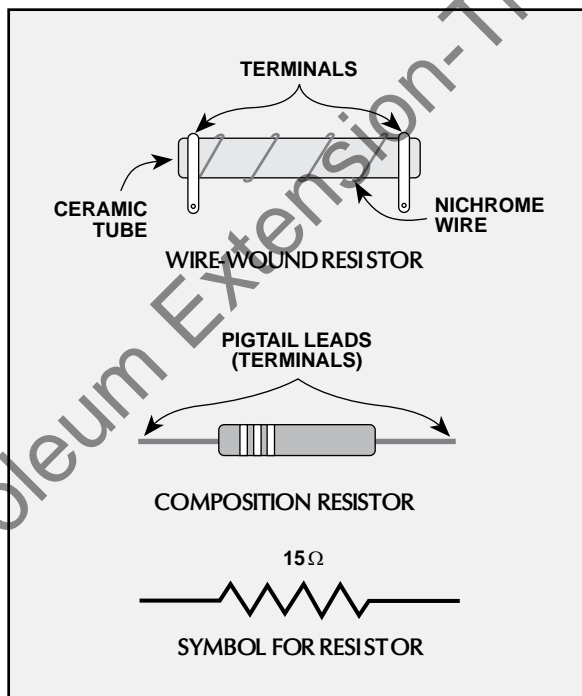

Figure 46 Two types of resistors and the symbol for a resistor

symbol for a resistor, which is used in schematics (drawings) of circuits. Also shown is the Greek letter Ω (omega), which stands for ohms. The resistor in figure 46 is a 15-ohm, or 15- Ω , resistor.

Wire-Wound Resistors

Wire-wound resistors consist of high-resistance wire wound on a ceramic spool or tube. Wire-wound resistors give off a large amount of heat; so, they are used in well-ventilated circuits. Manufacturers often employ Nichrome wire in wire-wound resistors because of its high resistance. A wire-wound resistor's value in ohms depends on the length of the wire wound on the tube, the diameter of the wire, and the grade of Nichrome wire. Resistance in wire-wound resistors is usually given as *ohms per mil-foot*. Thus, the longer the wire and the heavier, or thicker, its gauge, the higher is its resistance.

As mentioned earlier, wire-wound resistors give off heat and heat speeds up *oxidation*. Nichrome wire not only has high resistance, but also it resists oxidation. That is, Nichrome wire does not readily combine with oxygen in the air and oxidize. Just as rust damages or destroys an iron or steel object, oxidation can damage or destroy the wire on a wire-wound resistor. Therefore, iron wire is not satisfactory for resistors because it rapidly oxidizes.

Wire-wound resistors can handle large amounts of power and can be made to relatively close tolerances. They are rugged and reliable, they have low temperature coefficients—that is, temperature changes do not significantly affect their resistance—and they are stable under most operating conditions. Also, low-resistance wire-wound resistors with close tolerances are very economical to make.

On the other hand, wire-wound resistors are not available in as wide a range of resistance values as film and composition resistors. Also, for a given *power rating* and resistance value, they are significantly larger than the other two. (A resistor's power rating

9

Electromagnetic Equipment

TRANSFORMERS

When a transformer is installed in a circuit, electricity of a given voltage and current flows into the transformer. The transformer then converts, or transforms, the voltage and current to a higher or lower value. The higher or lower values then flow to the remainder of the circuit in which the transformer is installed. For example, if 110 volts enters a transformer, the transformer can change it to, let's say, 1,110 volts before the voltage flows elsewhere in the circuit. In this case, input to the transformer is 110 volts, while output is 1,110 volts. On the other hand, 110 volts may flow into a transformer and the transformer can change it to 11 volts of output. Similarly, a transformer can change an input current of 1 ampere to 5 amperes and vice versa.

Transformers are essential in *power distribution systems*. Power distribution systems deliver electric power from a source of generation to a place of utilization. Without transformers, electric power cannot easily be transmitted over great distances. The electrical generation and transmission system of Hoover Dam in the western United States is a good example of how transformers are used in a power distribution system. The generators at the foot of the dam produce alternating current at 13,000 volts. Transformers step up this voltage to 287,500 volts for transmission through wires to Los Angeles, California, which is 200 miles (320 kilometres) away. In Los Angeles, additional transformers all over the city step it down to 440, 220, and 110 volts for use in industry, homes, and offices.

The reason for stepping voltage up and down to transmit it long distances is explained by the behavior of electricity when it travels through a conductor. When current passes through a conductor, such as a wire, some electrical energy is converted to heat, which is a loss of electrical energy. The amount of energy lost is proportional to the square of the number of amperes of current. That is, the higher the amperage of the current, the greater is the energy loss. The amount lost also depends on the conductor's

size, or gauge. The larger the conductor, the less is its resistance and the lower is the heat loss through it. Another factor concerns the power law, which is $P = VI$, where power in watts (P) is equal to voltage (V) in volts times current (I) in amperes.

Let's say, for example, that 880 watts of power is to be transmitted. From the power law, note that any combination of volts and amperes that produces a product of 880 watts is possible. For example—

1. 110 volts \times 8 amperes = 880 watts.
2. 220 volts \times 4 amperes = 880 watts.
3. 440 volts \times 2 amperes = 880 watts.
4. 880 volts \times 1 ampere = 880 watts.

In this case, the most desirable condition for transmitting the power is 880 volts and 1 ampere, because low amperage causes less heat loss in the conductor. The most efficient way to transmit alternating current is at high voltage and low amperage.

Figure 70 illustrates the use of transformers between a generating station at a dam and the electric motor on an oilwell pumping unit. The power leaves the dam at high voltage and low amperage

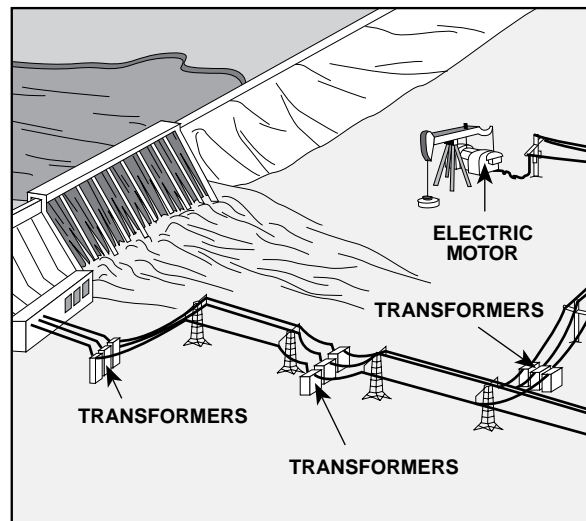

Figure 70 Use of transformers in a distribution system

Semiconductors and Applications

In the years since their invention in the late 1940s by physicists at Bell Laboratories, transistors and similar semiconductor components have virtually replaced vacuum tubes and other conventional devices in electronic equipment. Terms such as *vacuum tube*, *thyatron*, *triode*, and the like are virtually unheard today.

Semiconductors, which include *diodes*, *transistors*, and *light-emitting diodes (LEDs)*, among many other such components, offer several advantages over vacuum tubes. Semiconductors are small, lightweight, rugged, and efficient. What is more, they require no warm-up time and can operate under severe environmental conditions.

BASIC SEMICONDUCTOR THEORY

Semiconductors are *solid-state* devices that depend on the flow of electric charges in a solid for their operation. A semiconductor's resistance to current flow is less than the resistance of insulators, or nonconductors. However, a semiconductor's resistance is greater than a conductor's. Stated another way, the conductivity of a semiconductor is higher than a nonconductor but is lower than a conductor.

The conductivity of a material depends on the number of free electrons contained in its atomic structure. For example, a conductor such as copper has 1.64×10^{24} free electrons per cubic centimetre, while an insulator such as rubber has only three or four free electrons per cubic inch. Interestingly, the most common materials used to make semiconductors—*silicon* and *germanium*—are nonconductors in their pure states. They have no free electrons and become semiconductors only after manufacturers add impurities.

Semiconductor Materials

Manufacturers make most semiconductors from silicon. They rarely use germanium, except in special applications, because germanium cannot operate at high temperatures. Silicon, on the other hand, can operate at high temperatures.

Four electrons in the outer ring, or shell, orbit the nucleus of a silicon atom. Electrons in the outer ring of an atom are *valence electrons*. Valence electrons in one atom are available to combine with valence electrons of other atoms. When valence electrons of atoms combine, they form a new substance. For example, when the valence electrons of silicon combine with the valence electrons of oxygen, silicon dioxide (SiO_2) is formed, which is one of the most common substances on earth in that it is the main component of sand.

Besides valence electrons in one atom of one element combining with the valence electrons of a different atom, the valence electrons can also combine with the valence electrons of the same atom. When valence electrons of one element combine with the valence electrons of the same element, they form *electron-pair bonds*. An electron-pair bond is the combining of atoms (the bonding) in which each atom of a bond pair contributes one electron to form a pair of electrons.

Silicon has a crystal structure. That is, silicon is a homogenous solid whose atoms are arranged in a regularly repeating pattern. When a substance occurs in such a pattern, it is a *crystal* or has a crystalline structure. The four valence electrons of silicon are tightly bound in its crystalline structure by electron-pair bonds. This type of structure is called a *lattice*. (A lattice, in this sense, is the regular geometrical arrangement of points or objects over an area in space.) In a lattice, the four electrons of each atom form electron-pair bonds with one valence

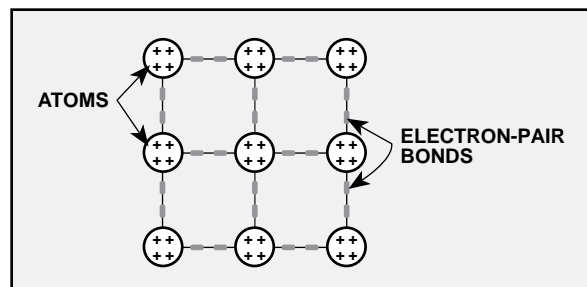

Figure 98 Lattice structure of semiconductor crystals

11 Digital Logic

We are firmly entrenched in a world where *digital logic* equipment and systems have become the dominant means of computation and communication. Several years ago, analog equipment dominated because digital devices had not been developed to the point of widespread use. Development of solid-state electronics, logic functions, and integrated circuits became commercial in the late 1960s and became fully developed in the 1970s. Logic functions, such as AND, OR, NAND, NOR, and *flip-flop circuits*, became available at low cost and led to the replacement of electromechanical relays. (A flip-flop circuit is a type of electronic circuit in which either of two active devices may remain conducting, with the other nonconducting, until the application of an external pulse.) However, replacement was passive—that is, the change from electromechanical relays to logic circuits was made only when it became necessary to replace a bad relay.

In the 1980s, a new integrated circuit was introduced: the microprocessor. Microprocessors allowed interaction between the user and the desired output. Further development of microprocessors led to production of calculators, digital phones, digital computers, and programmable logic controllers (PLCs). Today, supervisory control systems, digital telemetry devices, data acquisition equipment, and similar equipment are widely available. Because they are so widespread, these devices are usually well within economic reach of most consumers and companies.

BINARY NUMBERS

Because digital logic and the equipment that use it are based on the binary number system, this section further explores the concept. Earlier, basic concepts of digital and binary numbers, which use the symbols 1 and 0 to represent logic states or conditions, were discussed. This section builds on these concepts.

Binary Arithmetic

Binary numbers are different from decimal numbers in that binary numbers use base 2 and decimal

numbers use base 10. All decimal numbers can be represented as the number 10 raised to some power, and all binary numbers can be represented as the number 2 raised to some power.

The decimal system uses digits ranging from 0 to 9, while the binary system uses only the digits 0 and 1. The use of only two digits fits in well with electrical systems, because 0 can represent the absence of voltage while 1 can represent the presence of voltage. Switches or solid-state devices can establish the presence or absence of voltage.

In all numbering systems, a number takes on a weighted value according to its position to a reference point. In binary systems, this reference point is the *binary point*. Decimal systems take on weight relative to the position of the *decimal point*. A binary point is similar to the decimal point. A decimal point is a dot placed between numbers to indicate the point where numbers take on positive or negative powers of 10 (positive to the left of the decimal point and negative to the right of the decimal point). Because binary numbers are used in the binary system, the point is called the binary point, rather than the decimal point. In the binary system, numbers to the left of the binary point are raised to positive powers of 2, while numbers to the right of the binary point are raised to negative powers of 2. For example—

$$\begin{array}{cccccccc} & & & \text{Binary Point} & & & & \\ & & & \downarrow & & & & \\ 2^3 & | & 2^2 & | & 2^1 & | & 2^0 & | & 2^{-1} & | & 2^{-2} & | & 2^{-3} & | & 2^{-4} \end{array}$$

In the base-10 decimal system, a number becomes 10 times larger each time it is moved one position to the left of the decimal point. For example, the number 3,747 can be represented in weighted columns as—

$$\begin{array}{cccc} 10^3 & 10^2 & 10^1 & 10^0 \\ 1,000 & 100 & 10 & 1 \\ 3 & 7 & 4 & 7 \end{array}$$

Thus, the number 3,747 also means $3,000 + 700 + 40 + 7 = 3,747$.

12 Electrical Test Instruments

A large part of the world's population is served by a group of persons who perform special services related to the repair and maintenance of machines. These persons are mechanics, electricians, and technicians who use special instruments to locate points of trouble. And, once they determine the problem, they often use special tools to repair malfunctioning equipment and machines. For example, auto mechanics use special tools such as pressure, vacuum, temperature, and feeler gauges to measure and adjust engines. Mechanics also use a variety of electronic instruments when dealing with automobiles. Special scopes allow them to study the performance of ignition systems, *dwell meters* allow them to set timing (on older cars), and rpm meters (tachometers) allow them to set engine idle speeds. They also use voltmeters, ammeters, and ohmmeters to locate trouble in electrical systems and to help them make engine adjustments.

However, electronics technicians are likely to use the largest array of test and measuring instruments. They are engaged in the maintenance and repair of industrial instrumentation systems that employ electronic controls and they must know about several testing, measuring, and calibrating devices.

An instrumentation technician or mechanic not only uses ordinary pressure gauges and mechanical measuring devices, but also many test instruments that measure and observe the various aspects of electricity. These aspects include voltage, current, resistance, frequency, and wave shape.

D'ARSONVAL MOVEMENTS

An electricity detection device that has been in existence for over 200 years is the electroscope (fig. 159). An electroscope consists of a metal rod with a ball on the end of it, a strip of gold leaf, a metal cylinder, and a rubber stopper. When the rod and leaf take on the same electric charge—either positive or negative—the like charges drive the free end of the thin and limber leaf away from the rod, just as the same poles of a magnet repel each other.

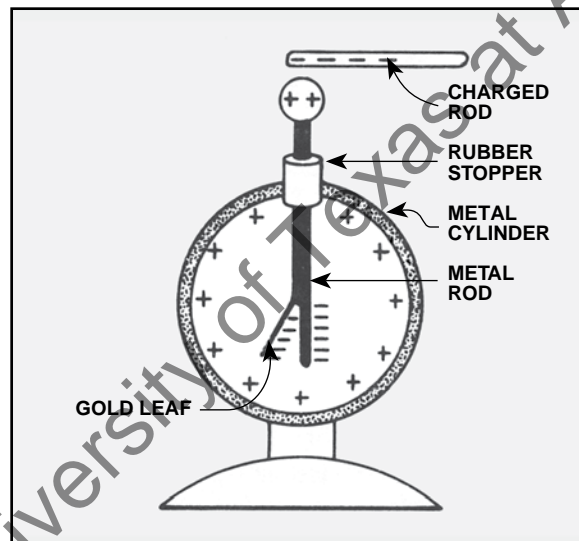

Figure 159 Simple electroscope

In figure 159, a negatively-charged rod is held near the metal ball. Electrons are repelled to the lower end of the metal rod and onto the gold leaf. Electrons in the rod and leaf repel one another, pushing the leaf away from the rod. As scientists such as Volta, Galvani, and Coulomb, all of whom worked in the early 1800s, recognized, the leaf's movement confirms the presence of electricity. Later, other scientists recognized the close relationship between electricity and magnetism and began using electric current produced by chemical and mechanical means. From these beginnings, electrical researchers rapidly developed measuring and testing devices using magnetic fields.

Most modern testing and measuring instruments use a meter. Several kinds of meters are available, but most have a scale of values printed on a background that makes them easy to read. A pointer, when energized by the meter's leads being attached to the circuit or component to be tested, moves to some point on the scale. A user then reads the value opposite the pointer's tip. Meters display values of voltage, current, resistance, and other variables, such as rpm and *dwell angle*.

Most meters use a mechanism called a *d'Arsonval movement*. A meter with a *d'Arsonval movement*

Troubleshooting Techniques and Safety

Electronic control systems used in the petroleum industry are usually complex groupings of integrated circuits (ICs) that represent thousands of discrete components. Circuits are complicated; indeed, even the simplest systems can be very involved. To understand the function and characteristics of every component or module is virtually impossible. At the same time, however, modern systems possess many excellent features and they are relatively easy to troubleshoot—certainly easier than the equipment of two or three decades ago.

Consider, for example, a solid-state operational amplifier (op amp), called a 741 (fig. 187). It replaces a 1950s vintage assembly that contained at least a dozen vacuum tubes and scores of other components. To determine whether a 741 op amp is operating properly, a technician only has to take measurements at two or three points. On the other hand, troubleshooting the 1950s model required considerable skill and an extensive amount of time.

Besides integrated circuits, modular construction has also made modern-day systems easy to troubleshoot and service. Making components in modules dates back to the vacuum-tube era, but in those days the modules were bulky and expensive (fig. 188). Today, however, a technician can quickly and easily extract a malfunctioning module that may contain tens of thousands of discrete components from a cardholder or socket and replace it with a module known to be operational (fig. 189).

RECORDKEEPING

It is very important to keep accurate troubleshooting records. Often, the operation and maintenance manuals that accompany a particular piece of equipment contain forms or special pages for recordkeeping. If they do not, then the technician responsible for the equipment's upkeep should start a record. Indeed,

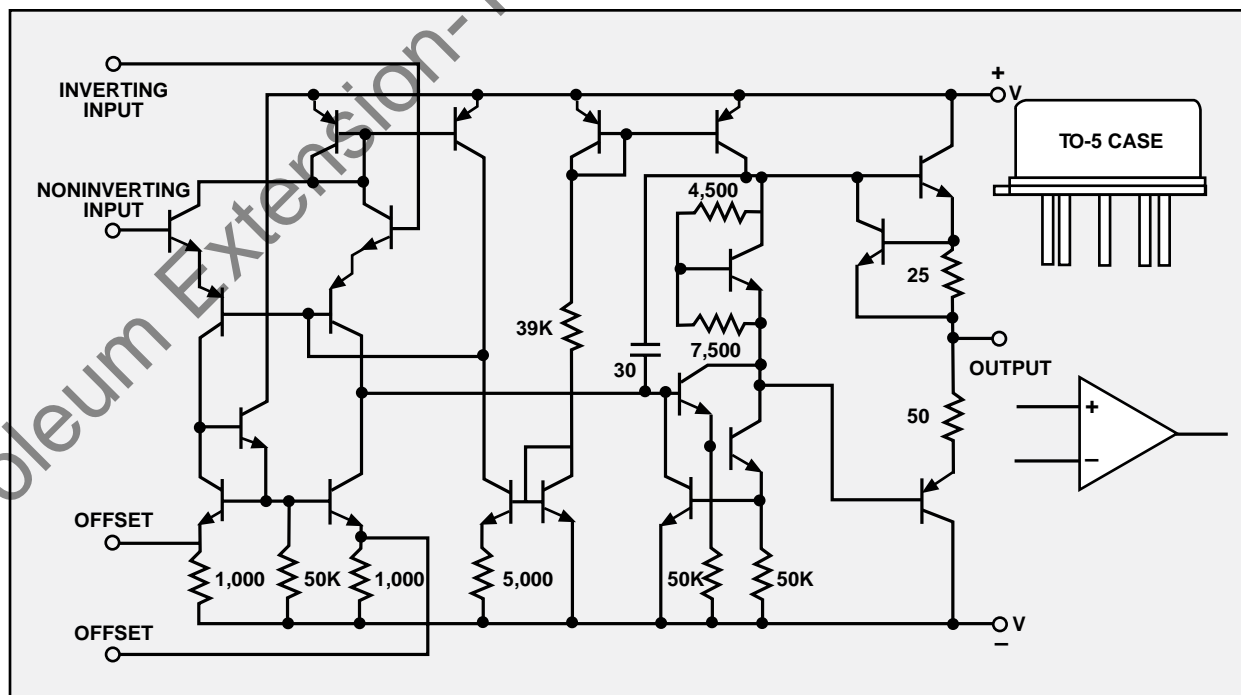

Figure 187 Circuit diagram of a type 741 op amp with a typical package format

To obtain additional training materials, contact:

PETEX
THE UNIVERSITY OF TEXAS AT AUSTIN
PETROLEUM EXTENSION SERVICE
10100 Burnet Road, Bldg. 2
Austin, TX 78758

Telephone: 512-471-5940

or 800-687-4132

FAX: 512-471-9410

or 800-687-7839

E-mail: petex@www.utexas.edu

or visit our Web site: www.utexas.edu/ce/petex



To obtain information about training courses, contact:

PETEX
LEARNING AND ASSESSMENT CENTER
THE UNIVERSITY OF TEXAS
4702 N. Sam Houston Parkway West, Suite 800
Houston, TX 77086

Telephone: 281-397-2440

or 800-687-7052

FAX: 281-397-2441

E-mail: plach@www.utexas.edu

or visit our Web site: www.utexas.edu/ce/petex

Petroleum Extension - The University of Texas at Austin

Petroleum Extension-The University of Texas at Austin

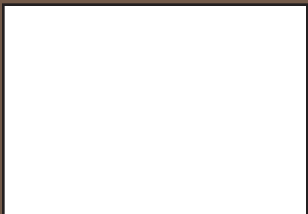

CATALOG NO. 1.41040
ISBN 0-88698-199-9